

# FILTAIR® SWX Series

**Welding Safety and Health** 

## Quick Specs

### Industrial Applications

Schools and training facilities  
Manufacturing and fabrication  
Fixed welding cells/stations

### Processes

Stick (SMAW)  
Flux-cored (FCAW)  
MIG (GMAW)  
TIG (GTAW)

### Filter Media

490 sq. ft. (45.52 sq. m)

**Accu-Rated™ Airflow** 875 cfm (413 L/sec.)

**Sound Level at 5 ft. (1.5 m)**

**Standard:** Approximately 75 dBA  
**ZoneFlow™:** Approximately 80 dBA

**Extraction Arm** 8 in. (203 mm) diameter

**Telescoping:** 3–4.5 ft. length  
**Standard:** 7, 10 or 12 ft. length  
**ZoneFlow™:** 10 or 12 ft. length

## Wall- or column-mounted fume extraction systems designed specifically for welding.

Self-cleaning filter (SWX-S) model is available with choice of telescoping, standard or ZoneFlow extraction arm.

Disposable filter (SWX-D) model is available with choice of telescoping or standard extraction arm.

See page 11 for optional dual-arm add-on packages.

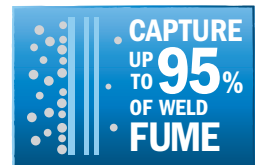

Standard high-efficiency filter designed to capture weld fume

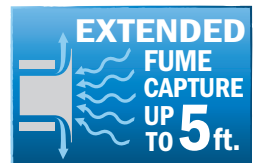

Exclusive ZoneFlow™ technology extends weld fume capture area



Filters air for welder and facility

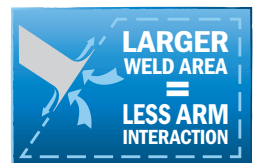

Better protection, more welding

**The capture zone redefined. Innovative, extended-capture fume extraction system designed specifically for welding.**

Exclusive ZoneFlow™ technology creates a much larger capture area than existing source-capture products and minimizes arm interactions. See page 2 for more information.

Have a certified industrial hygienist test the air in your facility to determine equipment requirements and ensure adequate protection from contaminants.

**NEW!**

Self-cleaning filter (SWX-S) model now available with ZoneFlow technology.



Fume extractor is warranted for one year, parts and labor.



**Miller Electric Mfg. LLC**  
An ITW Welding Company  
1635 West Spencer Street  
P.O. Box 1079  
Appleton, WI 54912-1079 USA

**Equipment Sales US and Canada**  
Phone: 866-931-9730  
FAX: 800-637-2315  
International Phone: 920-735-4554  
International FAX: 920-735-4125

**MillerWelds.com**  





# ZoneFlow™ Technology

## Extend your fume capture zone

**Capturing fume at the source is critical to maintaining a clean breathing zone for the welder and keeping the facility clean.**

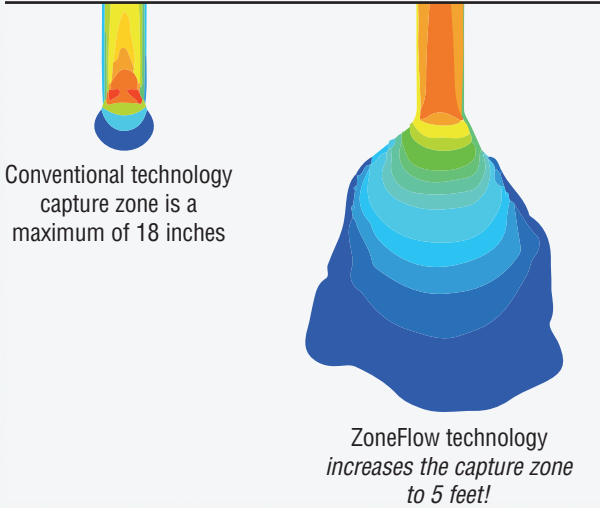
ZoneFlow technology offers up to five feet of fume extraction versus up to 18 inches from conventional source capture extractors. By increasing the area of weld fume capture, it dramatically reduces the amount of interaction a welder has with an arm.



## ZoneFlow tech talk

**ZoneFlow technology creates a negative pressure zone that extends the weld particulate capture distance.**

Air moving into the arm is still about 900 cfm. However, ZoneFlow technology also moves clean, filtered air out of the arm at approximately a 90-degree angle which creates a large negative pressure zone. This negative pressure zone forms a type of curtain that funnels the weld fume particulate towards the center of the arm, maximizing capture and extending the capture zone up to five feet deep and four feet wide.

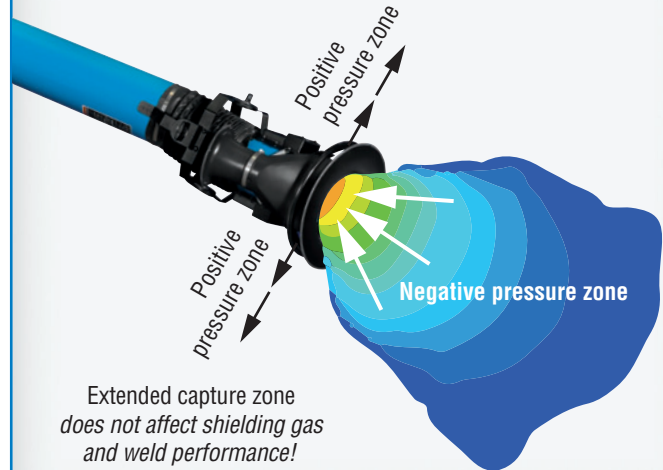

**Designed to capture fume in larger weld areas while minimizing interactions with the arm.**

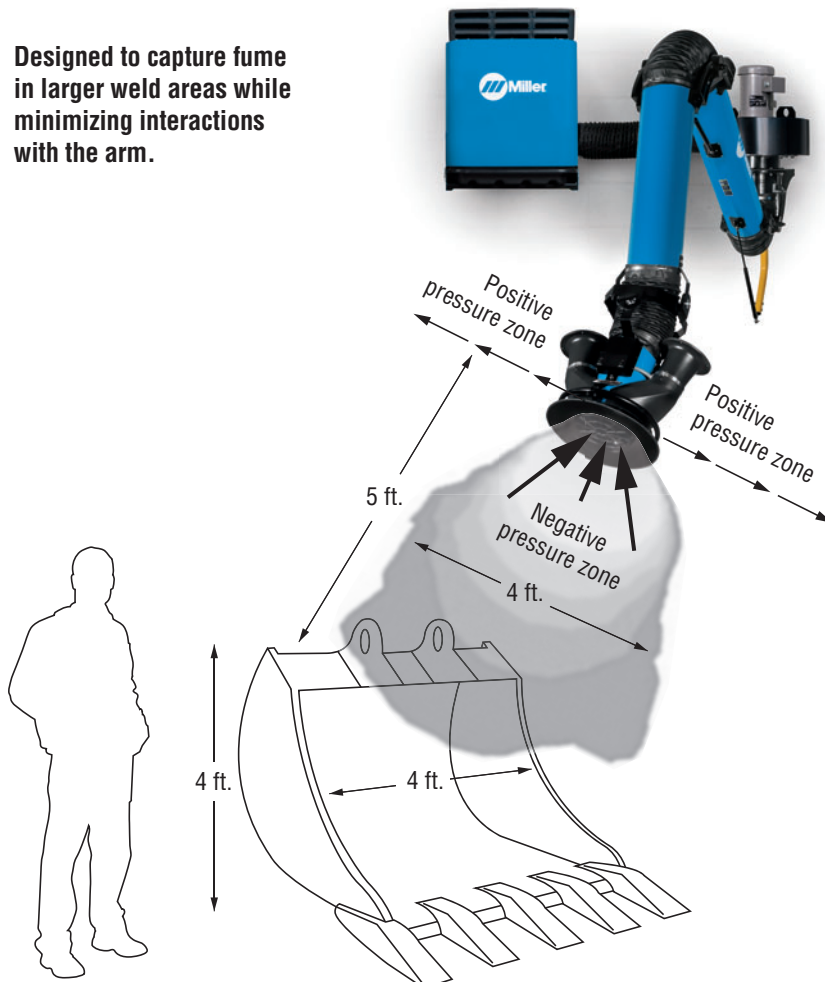

## Specifications (Subject to change without notice.)

Filter Media	Accu-Rated™ Airflow	Extraction Arm Diameter	Sound Level	Motor	Power	Dimensions	Net Weight without Arm
490 sq. ft. (45.52 sq. m)	875 cfm (413 L/sec.)	8 in. (203 mm)	<b>Standard</b> Approximately 75 dBA at 5 ft. (1.5 m) <b>ZoneFlow™</b> Approximately 80 dBA at 5 ft. (1.5 m)	1 hp, 3,450 rpm	<b>Blower motor</b> 115 V, 1-phase, 60 Hz at approximately 11.9 A <b>ZoneFlow™</b> 115 V, 1-phase, 60 Hz at approximately 12 A	H: SWX-D: 29 in. (737 mm) H: SWX-S: 33 in. (838 mm) W: 27.25 in. (692 mm) D: 33 in. (838 mm)	<b>Cabinet</b> SWX-D: 130 lb. (59 kg) SWX-S: 195 lb. (88 kg) <b>Blower/bracket</b> 95 lb. (43 kg)

## System Benefits

### SWX filter cabinet

#### Disposable and self-cleaning filter models available.

The disposable filter model works great for light duty and intermittent welding operations. Upgrade to self-cleaning models with high arc on time, extracting from heavy-fume processes, or when welding aluminum or galvanized materials. Self-cleaning models are also recommended for most dual-arm applications.

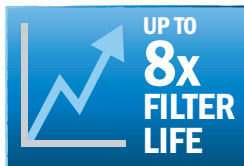

#### Self-cleaning model has additional features.

Designed to capture weld fume particles with a cleanable filter and safely deposit them in an integrated particle bin, the self-cleaning model provides unrivaled filtering performance.

One-minute cleaning cycle operates with a push of a button on the control panel.

Latches release a disposal drawer allowing it to slide out to provide easy and convenient access to empty out the collected particles.

*Note: Compressed air required to operate cleaning mechanism.*



Disposable filter (SWX-D) model



Self-cleaning filter (SWX-S) model

### Fume extraction blower

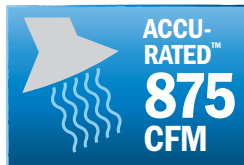

#### Class leading suction power.

High-performance fan generates 1,200 cfm and creates an Accu-Rated minimum of 875 cfm extraction at the hood to better capture weld fumes and provide a cleaner environment.



### Easy-to-operate extraction arms

#### Telescoping arms extend up to 4.5 feet and are ideal for smaller spaces.

Designed to fit small booth spaces used in training centers and educational booths. Telescopes from 3 to 4.5 feet with a wide range of motion to cover all positions.



Telescoping arm

#### Standard/ZoneFlow arms in multiple different sizes cover larger areas.

Designed to cover larger spaces, the standard arms are available in 7-, 10- and 12-foot versions and the ZoneFlow arms in 10- and 12-foot versions. External brackets and adjustments allow air to pass through with less resistance giving you stronger cfm (airflow).



Standard arm

## Cleaner air with FilTek XL filters

The FilTek XL filter's higher MERV rating means unrivaled filtering performance.

Filters are rated on a MERV scale, which measures filter efficiency based on particle count. MERV ratings range from 1–16, with 16 being the best at filtering small particles — such as those found in weld fumes. The vast majority of weld fumes are less than one micron in diameter, or roughly 1/100th the width of a human hair.



Filters in common air filtration systems often have MERV ratings between 7–11. FilTek XL filters are rated at class-leading MERV 15–16 to capture up to 95 percent of weld fume particulates.

### Filter media performance summary

FilTek XL filters have the highest efficiencies and lowest pressure drops to capture better, last longer, and lower operating costs.

## MERV Comparison

Applicable Weld Fume MERV Rating Categories <sup>1</sup>	Particle Size Range Efficiency % <sup>2</sup>		
	0.3 to 1 µm	1 to 3 µm	3 to 10 µm
10	Not rated	50–65%	85%
11	Not rated	65–80%	85%
12	Not rated	80–90%	85%
13	<75%	90%	90%
14	75–85%	90%	90%
15 Miller® FilTek XL	85–95%	90%	90%
Percentage of Weld Fume Particle Size <sup>3</sup>	75–95%	15%	10%

<sup>1</sup>American Society of Heating, Refrigeration and Air Conditioning Engineers (ASHRAE) 52.2

<sup>2</sup>National Air Filtration Association (NAFA) Guide

<sup>3</sup>Jenkins, Pierce, Edgar, Particle Size Distribution of GMAW and FCAW

Filter Media Type	Weld Fume Capture Efficiency	Pressure Drop	Relative Cost
Cellulose	Very low	Low	\$
Cellulose blend	Low	Moderate	\$
Spunbond polyester	Moderate/high	High	\$\$\$
Meltblown composite	High	High	\$\$
Miller FilTek XL	High	Low	\$\$

**FilTek XL filters provide high efficiencies and low operating pressure to out-filter, outperform, and outlast all the rest.**

## Not just filters — FilTek XL filters

The FilTek XL filter media design results in extended filter life, higher efficiency and stronger suction, resulting in a cleaner work space and improved weld fume capture. Filter media from FilTek XL high-volume filters are made up of a durable substrate with an engineered fiber designed to capture even the smallest of weld fume particles, while maintaining the highest level of efficiency.

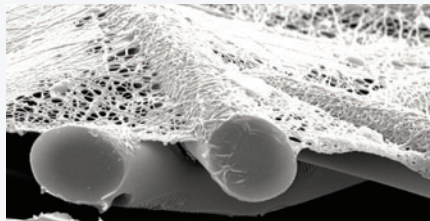

Clean FilTek XL media

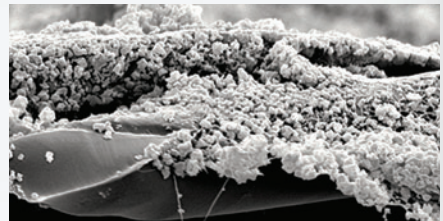

Surface loaded FilTek XL media (substrate still clean)

# Telescoping Extraction Arm

**Pre-assembled arms** for easy setup.



**Easy-to-use telescoping arm** is ideal for small spaces and offers reliable and accurate positioning across the full range of motion of the arm. Easy adjustments and maintenance ensures long-lasting operation. Pre-assembled telescoping arms can extend from 3 to 4.5 feet.

**Durable bellmouth-shaped hood** features a convenient 360 degree rotation for unlimited positioning. The FILTAIR extraction hood captures weld fumes at a greater distance from the source than other hood designs. This also means less hood adjustments for longer welds.

## Telescoping Arm Coverage Area

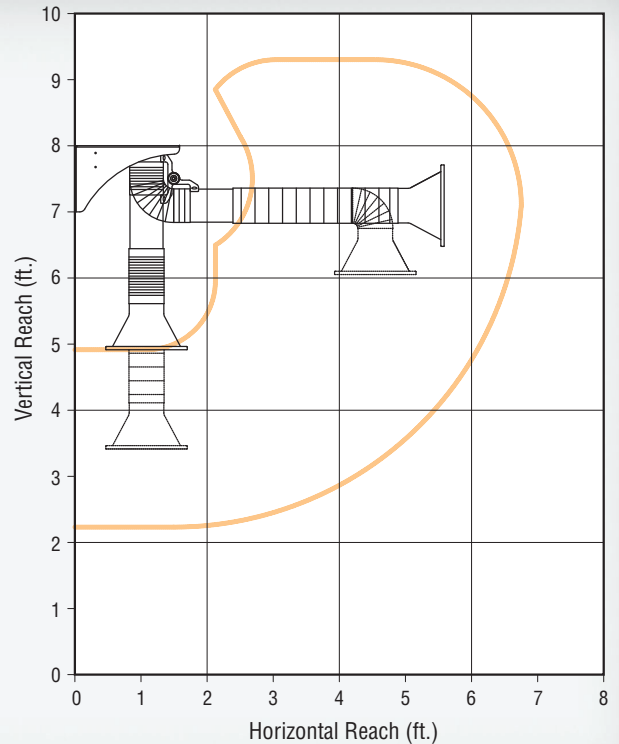

# Standard Extraction Arm

**Pre-assembled arms**  
for easy setup.



**Easy-to-operate standard arm** with external adjustments so air can pass through with less airflow resistance, giving you stronger CFM (airflow). It offers reliable and accurate positioning across the full range of motion of the arm, as well as easy adjustment and maintenance to ensure long-lasting operation. Pre-assembled extraction arms are available in 7-, 10- or 12-foot lengths.

**Durable bellmouth-shaped hood** features a convenient 360 degree rotation for unlimited positioning. The FILTAIR extraction hood captures weld fumes at a greater distance from the source than other hood designs. This also means less hood adjustments for longer welds.

## Standard Arm Coverage Area

- 7 ft. Extraction Arm  
Min. ceiling height:  
12.33 ft. (3.8 m)
- 10 ft. Extraction Arm  
Min. ceiling height:  
13.33 ft. (4.1 m)
- 12 ft. Extraction Arm  
Min. ceiling height:  
14.33 ft. (4.4 m)

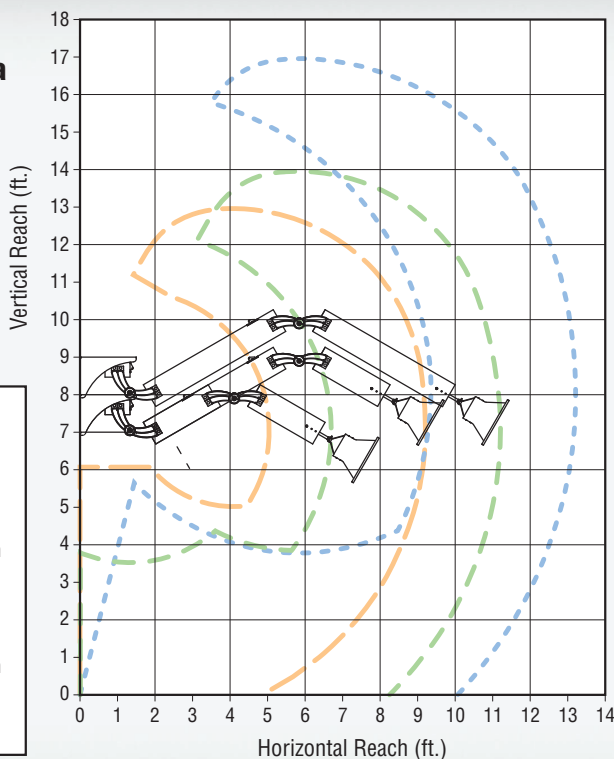

# ZoneFlow™ Extraction Arm



**Easy-to-operate ZoneFlow arm** with external adjustments so air can pass through with less airflow resistance, giving you stronger CFM (airflow). It offers reliable and accurate positioning across the full range of motion of the arm, as well as easy adjustment and maintenance to ensure long-lasting operation. Extraction arms are available in 10- or 12-foot lengths.

**ZoneFlow arm** creates a negative pressure zone that funnels air to the center of the arm from greater distances. The arm features convenient 360-degree rotation for unlimited positioning, which means fewer hood adjustments and extended welding time.

## ZoneFlow Arm Coverage Area

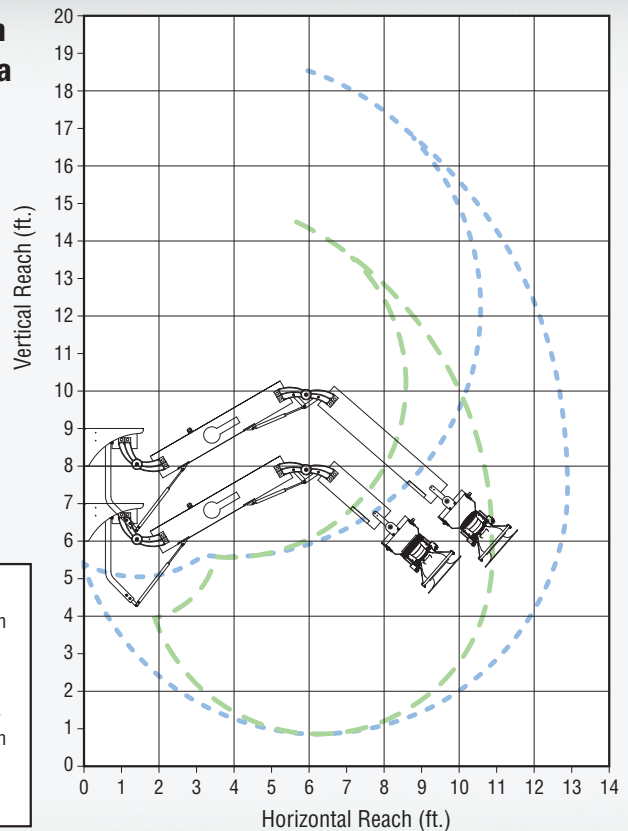

--- 10 ft. Extraction Arm  
Min. ceiling height:  
13.33 ft. (4.1 m)

--- 12 ft. Extraction Arm  
Min. ceiling height:  
14.33 ft. (4.4 m)

# ZoneFlow™ Set-Up Guide

## 1. The fume extraction zone

ZoneFlow technology is designed to create a large, effective weld fume extraction zone. It will operate most effectively in areas where air currents or turbulence are minimal. When used properly, it will capture a large percentage of the fumes at the source, and the larger capture area will allow a welder to complete more welding while reducing interaction with the arm.

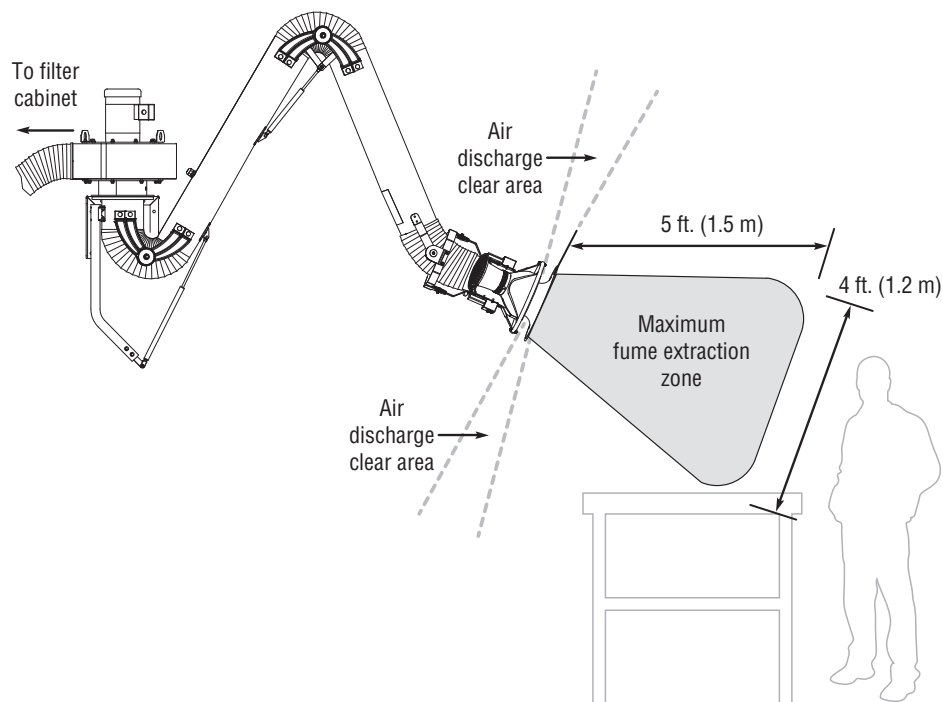

### Air discharge clear area

To maximize the fume extraction zone, **DO NOT OBSTRUCT AIR DISCHARGE** from the arm.



The arm discharges clean, filtered air just behind the hood at approximately a 90-degree angle, creating an “air curtain” that funnels the weld fumes towards the center of the arm, maximizing capture. Maintain at least a 5-foot clear area **ON ALL SIDES** of the hood to avoid disturbing this air discharge. Disrupting the flow will reduce the amount and distance of fume captured.

## 2. Hood position and operator safety

ZoneFlow technology is designed to help protect the user from welding-specific airborne contaminants but must be used correctly to be fully effective.

Position the hood in front of or at side of the weld area in order to draw weld fumes **AWAY** from the operator. To maximize the extraction zone the angle of arm should be 30–45 degrees off horizontal.

**DO NOT** position the hood behind the welder, or in any other place that will cause the weld fumes to be pulled across the welder or through his breathing space.

**BE AWARE** that air turbulence or movement may disrupt the effectiveness or position of the fume extraction zone and increase the possibility that the welder may encounter weld fumes.

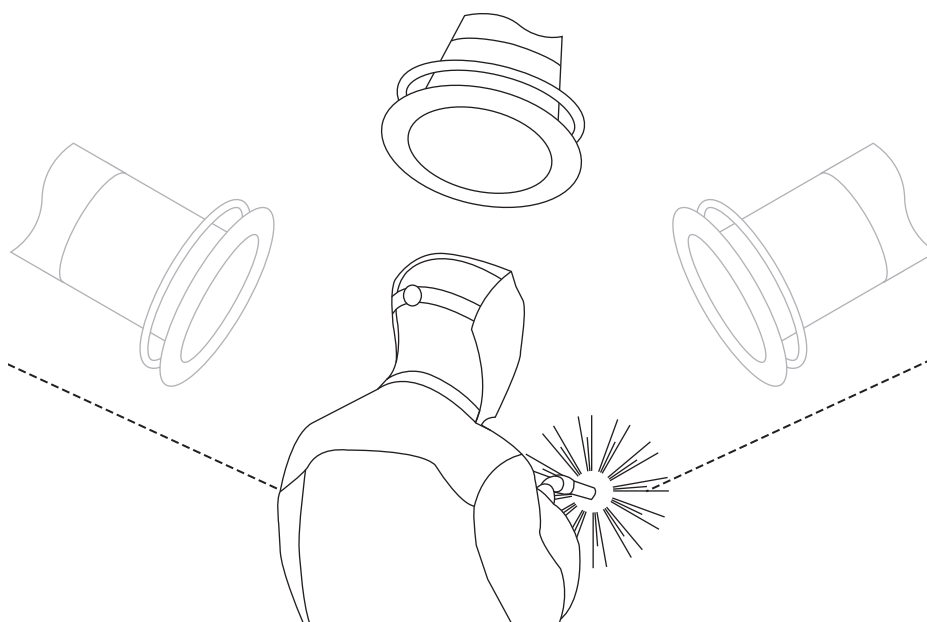

**KEEP HEAD OUT OF FUMES!**



# ZoneFlow™ Set-Up Guide

## 3. The effects of air currents or turbulence

ZoneFlow technology is designed to operate most effectively in areas where air currents or turbulence are minimal.

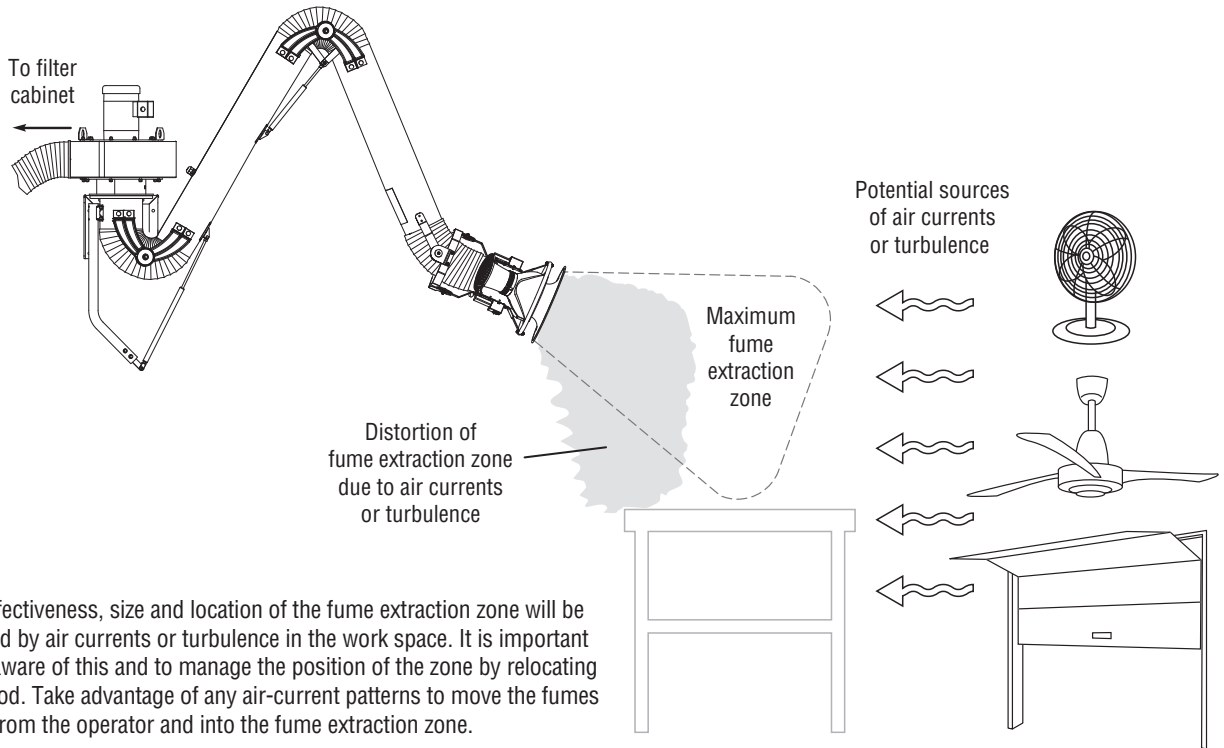

The effectiveness, size and location of the fume extraction zone will be affected by air currents or turbulence in the work space. It is important to be aware of this and to manage the position of the zone by relocating the hood. Take advantage of any air-current patterns to move the fumes away from the operator and into the fume extraction zone.

## 4. Compensate for air currents using screens or curtains

For the most efficient fume extraction in some environments, it may be necessary to actively manage the air currents to establish more predictable and stationary air space.

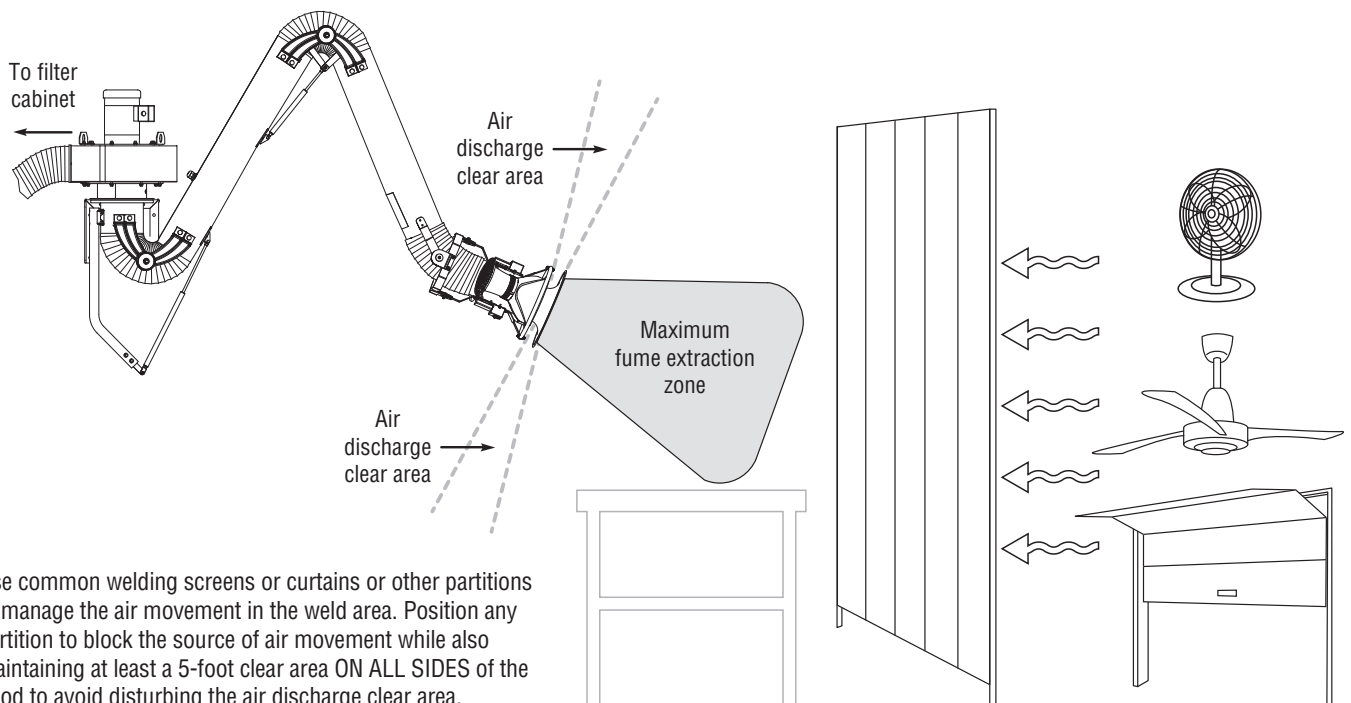

Use common welding screens or curtains or other partitions to manage the air movement in the weld area. Position any partition to block the source of air movement while also maintaining at least a 5-foot clear area ON ALL SIDES of the hood to avoid disturbing the air discharge clear area.

# Workstations and Training Booths



FILTAIR SWX system packages are easy to order and allow the flexibility to mix different arm types to solve various fume extraction challenges.

## Typical workstation and training booth installations

### FILTAIR® SWX Installation

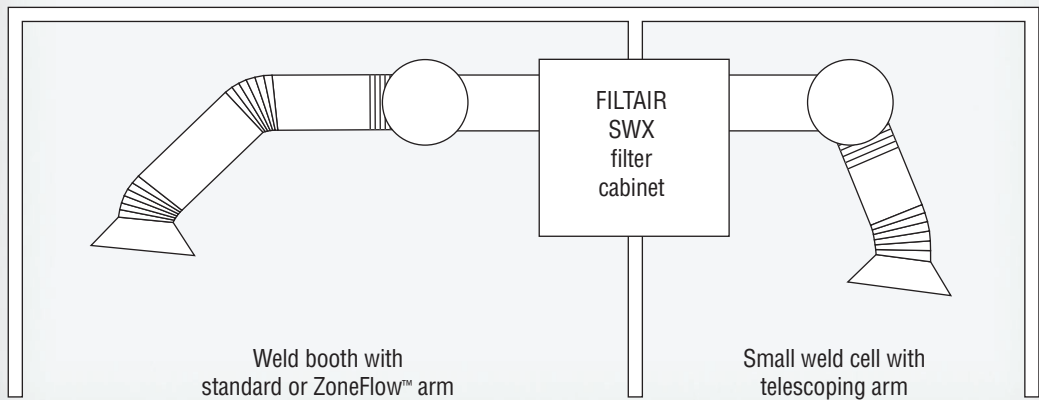
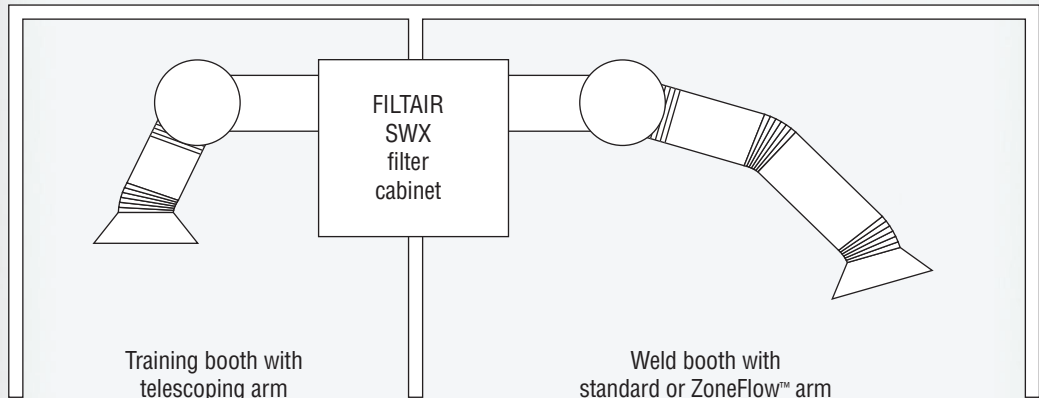

# Packages

## Telescoping arm

### Telescoping arm packages include:

- SWX filter cabinet (choose disposable filter or self-cleaning model)
- High-efficiency filter
- 115 V cleaning control box (self-cleaning model only)
- 115 V blower
- 115 V on/off control box
- Mounting bracket for blower/arm
- Flexible duct (7 x 37 in.)
- 8 in. diameter telescoping arm (3–4.5 ft.)

Note: 115 V wiring not included.

### Telescoping dual-arm add-on package includes:

- 115 V blower
- 115 V on/off control box
- Mounting bracket for blower/arm
- Flexible duct (7 x 37 in.)
- Backdraft dampers
- 8 in. diameter telescoping arm (3–4.5 ft.)

Note: 115 V wiring not included.



SWX-D (disposable filter) model shown.

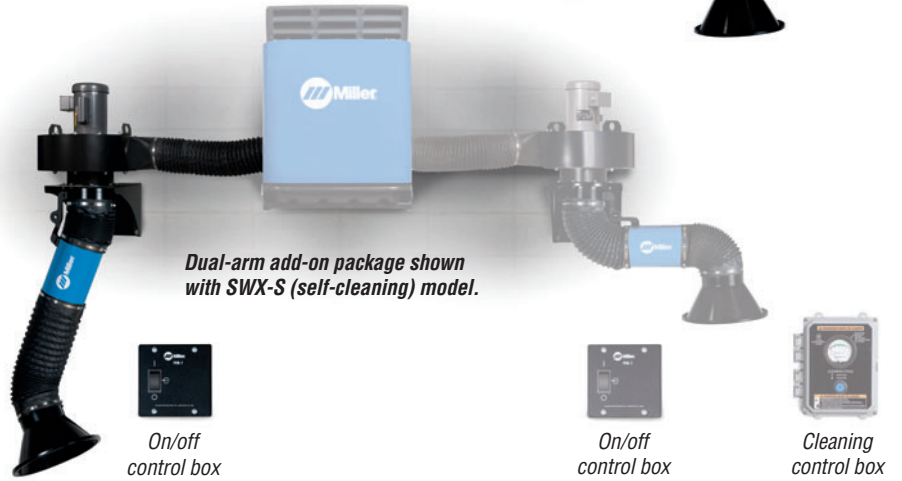

Dual-arm add-on package shown with SWX-S (self-cleaning) model.

## Standard/ZoneFlow™ arm

### Standard/ZoneFlow arm packages include:

- SWX filter cabinet (Standard: disposable filter or self-cleaning) (ZoneFlow: self-cleaning)
- High-efficiency filter
- 115 V cleaning control box (self-cleaning model only)
- ZoneFlow motor control box (ZoneFlow packages only)
- 115 V blower
- 115 V on/off control box
- Mounting bracket for blower/arm
- Flexible duct (7 x 37 in.)
- 8 in. diameter arm (Standard: 7, 10 or 12 ft.) (ZoneFlow: 10 or 12 ft.)

Note: 115 V wiring not included.

### Standard/ZoneFlow dual-arm add-on packages include:

- 115 V blower
- 115 V on/off control box
- ZoneFlow motor control box (ZoneFlow packages only)
- Mounting bracket for blower/arm
- Flexible duct (7 x 37 in.)
- Backdraft dampers
- 8 in. diameter arm (Standard: 7, 10 or 12 ft.) (ZoneFlow: 10 or 12 ft.)

Note: 115 V wiring not included.



SWX-D (disposable filter) model shown.

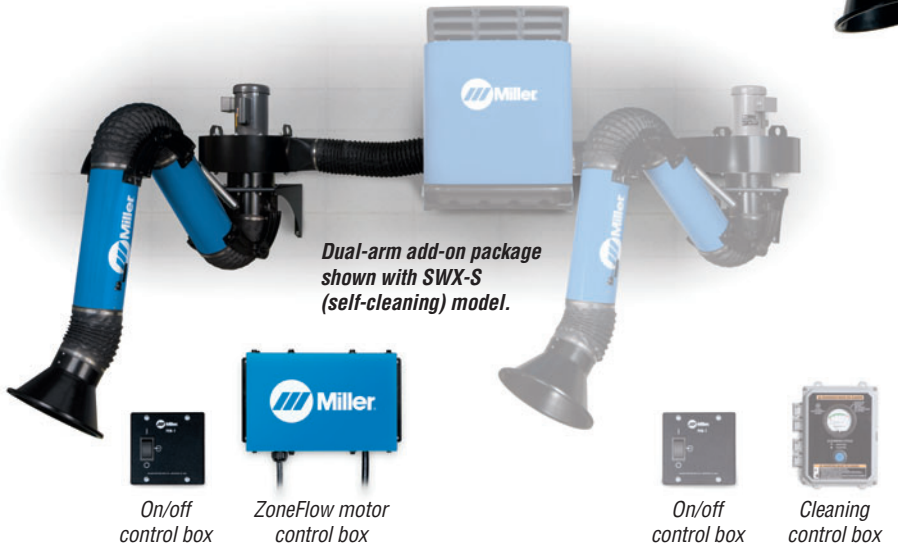

Dual-arm add-on package shown with SWX-S (self-cleaning) model.

## Genuine Miller® Accessories



**FilTek® XL Replacement Filters**  
**300539** Disposable  
**300540** Self-cleaning (shown)



**SWX Hood Light with Arc Sensor 300763** Field  
 The hood light with arc sensor illuminates the welding zone and enables the fume extractor to start automatically when welding begins.

*Note: Not compatible with ZoneFlow extraction arms.*

## Ordering Information

Equipment and Options	Stock No.	Description	Qty.	Price
<b>FILTAIR® SWX-D (Disposable Filter) Single-Arm Packages</b> (Includes SWX-D cabinet, disposable filter, blower, on/off control box, mounting bracket, duct, and 8 in. diameter arm. 115 V wiring NOT included.)	<b>951619</b>	With 3–4.5 ft. telescoping extraction arm		
	<b>951513</b>	With 7 ft. standard extraction arm		
	<b>951514</b>	With 10 ft. standard extraction arm		
	<b>951515</b>	With 12 ft. standard extraction arm		
<b>FILTAIR® SWX-S (Self-Cleaning Filter) Single-Arm Packages</b> (Includes SWX-S cabinet, self-cleaning control box and filter, blower, on/off control box, mounting bracket, duct, and 8 in. diameter arm. 115 V wiring NOT included.)	<b>951620</b>	With 3–4.5 ft. telescoping extraction arm		
	<b>951516</b>	With 7 ft. standard extraction arm		
	<b>951517</b>	With 10 ft. standard extraction arm		
	<b>951518</b>	With 12 ft. standard extraction arm		
	<b>951760</b> <b>951761</b>	With 10 ft. ZoneFlow™ extraction arm and motor control box With 12 ft. ZoneFlow™ extraction arm and motor control box		
<b>FILTAIR® SWX Dual-Arm Add-On Packages</b> (Includes blower, on/off control box, mounting bracket, duct, backdraft dampers, and 8 in. diameter arm. 115 V wiring NOT included.)	<b>951621</b>	With 3–4.5 ft. telescoping extraction arm		
	<b>951519</b>	With 7 ft. standard extraction arm		
	<b>951520</b>	With 10 ft. standard extraction arm		
	<b>951521</b>	With 12 ft. standard extraction arm		
	<b>951762</b> <b>951763</b>	With 10 ft. ZoneFlow™ extraction arm and motor control box With 12 ft. ZoneFlow™ extraction arm and motor control box		
<b>Base Components</b>				
SWX Cabinet (Includes filter and duct)	<b>300599</b> <b>300600</b>	With disposable filter With self-cleaning control box and filter		
FEB-1 Fume Extraction Blower (Includes on/off control box and mounting bracket)	<b>300691</b>	1 horsepower (FEB-1)		
Telescoping Extraction Arm (Arm only)	<b>301237</b>	3–4.5 ft. length, 8 in. diameter		
Standard Extraction Arms (Arm only)	<b>300980</b>	SA-W807, 7 ft. length, 8 in. diameter		
	<b>300981</b>	SA-W810, 10 ft. length, 8 in. diameter		
	<b>300982</b>	SA-W812, 12 ft. length, 8 in. diameter		
ZoneFlow™ Extraction Arms and ZoneFlow Motor Control Box	<b>951758</b> <b>951759</b>	SA-W810-ZF, 10 ft. length, 8 in. diameter SA-W812-ZF, 12 ft. length, 8 in. diameter		
	<b>FilTek® XL Replacement Filters</b>			
Disposable Filter	<b>300539</b>			
Self-Cleaning Filter	<b>300540</b>			
<b>Accessories</b>				
SWX Hood Light with Arc Sensor	<b>300763</b>	Field. Not compatible with ZoneFlow extraction arms		

Date:

Total Quoted Price:

**Please call toll-free 855-FILTAIR (855-345-8247)  
 for information on fume extraction solutions.**

Distributed by:

